

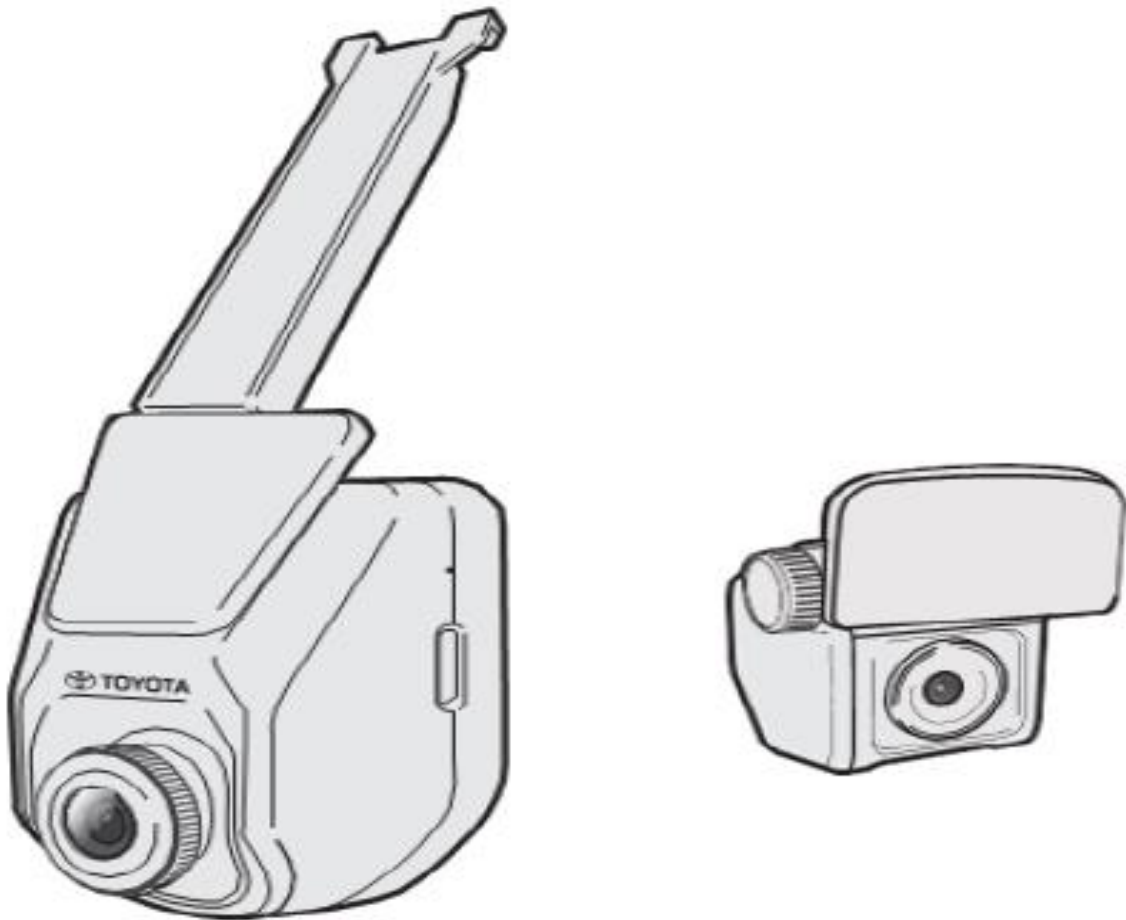

# DIGITAL VIDEO RECORDER (DVR)

## OWNERS MANUAL



Please read this manual for proper operation and keep it for future reference.



# TABLE OF CONTENTS

## DIGITAL VIDEO RECORDER (DVR)

Section	Title	Page
<b>1.0</b>	<b>Statements</b>	
1.1	Important notice	1
1.2	About Highway Buddy	1
<b>2.0</b>	<b>Introduction to the DVR</b>	
2.1	Front DVR	2
2.2	Rear DVR	2
2.3	DVR Overview	3
<b>3.0</b>	<b>Getting Started</b>	
3.1	Installing the memory card	4
3.2	Formatting the memory card	4
3.3	About the memory card	5
<b>4.0</b>	<b>Operating the DVR</b>	
4.1	Normal recording	6
4.2	Emergency recording	6
4.3	Capturing a photo	7
<b>5.0</b>	<b>Managing files on DVR</b>	
5.1	Playing Videos	8
5.2	Playing Rear Videos	8
<b>6.0</b>	<b>Highway Buddy</b>	
	Highway Buddy Functions	9
<b>6.1</b>	<b>Lane Departure Warning System (LDWS)</b>	
6.1.1	Introduction to LDWS	10
6.1.2	Limitations to LDWS	10
6.1.3	Changing Setting for LDWS	11
6.1.4	Operational Condition for LDWS	11
6.1.5	Conditions in which LDWS may not operate properly	11
<b>6.2</b>	<b>Forward Collision Warning System (FCWS)</b>	
6.2.1	Introduction to FCWS	13
6.2.2	Limitations to FCWS	13
6.2.3	Changing Setting for FCWS	13

Please read this manual for proper operation and keep it for future reference.



# TABLE OF CONTENTS

## DIGITAL VIDEO RECORDER (DVR)

Section	Title	Page
6.2.4	Operational Conditions for FCWS	14
6.2.5	Conditional in which FCWS may not operate even when there is no possibility for collision	14
6.2.6	Conditions in which FCWS may not function accurately	16
<b>6.3</b>	<b>Driver Alert (DA)</b>	
	Driver Alert (DA) Function	19
<b>7.0</b>	<b>Customizing the DVR</b>	
7.1	Video Recording Settings	20
7.2	System Settings	21
<b>8.0</b>	<b>Product Specification</b>	
	Specifiction	22

Please read this manual for proper operation and keep it for future reference.



# SECTION 1.0

## Statements

### 1.1 Important notice

Always use your best judgment, and operate your vehicle in a safe manner. Do not become distracted by the device while driving, and always be fully aware of all driving conditions. Minimize the amount of time spent viewing the device screen while driving.

Using this product does not change the requirement of the driver to take full responsibility for his or her behavior. This responsibility includes observing all traffic rules and regulations in order to avoid accidents, personal injury or property damage.

Please do not attempt removal of DVR unit from windshield – please visit your local Toyota Service Center if removal or calibration is required.

### 1.2 About Highway Buddy

Highway Buddy is a value-added feature that provides alerts to assist with Lane Departure and Forward Collision warnings, but it is not a replacement for the driver's attentiveness. The driver is still required to follow proper driving procedure to ensure personal safety, failure to do so may result in a serious accident, causing damage to property, serious injury or loss of life



# SECTION 2.0

## Getting Started

### 2.1 Front DVR

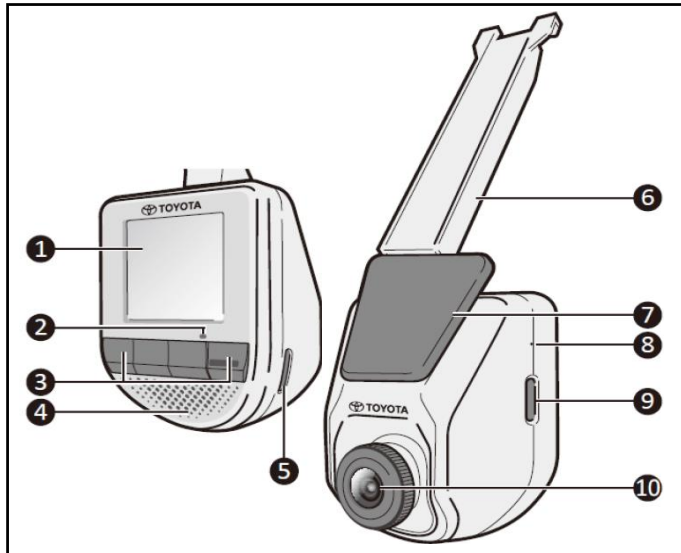

No.	Description
1	LCD SCREEN
2	RECORDING INDICATOR
3	FUNNCTION BUTTONS
4	SPEAKER
5	WIRING SLEEVE
6	WINDOW MOUNT
7	RESET BUTTON
8	MEMORY CARD SLOT
9	FRONT CAMERA

### 2.2 Rear DVR

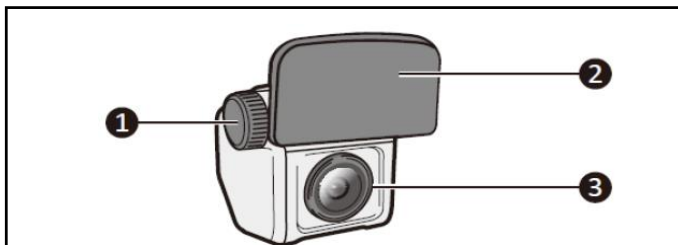

No.	Description
1	ADJUSTMENT BOLT
2	WINDOW MOUNT
3	REAR CAMERA

\* Only applicable for car variants that include Rear DVR camera

**Note:** Please do not adjust the Rear DVR. Optimum view has been set by the manufacturer



# SECTION 2.0

## Getting Started

### 2.3 DVR Overview

**Button layout and functions:** The DVR provides 4 function keys to control the corresponding icons displayed on the LCD screen. The keys' function may vary on different screens

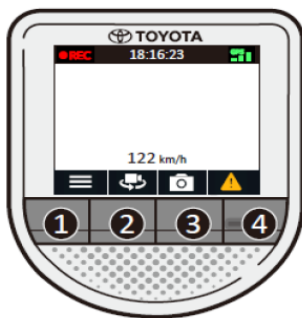

#### Home Screen

- ① Open the Menu screen
- ② Switches view between front and rear camera
- ③ Takes a photo
- ④ Manually start emergency recording



#### Manu Screen

- ① Acts as the BACK button  
<Press and hold to return to HOME screen>
- ② Moves to the previous option
- ③ Moves to the next option
- ④ Acts as the ENTER button

**System icons:** Various system icons on the status bar at the top of the screen provide the status information of your DVR. The displayed icons will vary depending on the function availability.

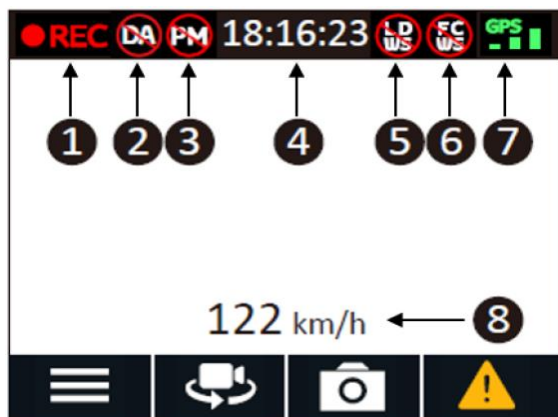

- ① Recording Indicator
- ② Driver Alert status
- ③ Current time
- ④ LDWS status
- ⑤ FCWS status
- ⑥ GPS signal
- ⑦ Current GPS car speed



# SECTION 3.0

## Operating Digital Video Recorder (DVR)

### 3.1 Installing the memory card

To install the memory card, Hold the card (MicroSD) by the edges and gently insert it into the slot until you hear a click. To remove a card, gently push the top edge of the card inwards to release it and pull it out of the slot.

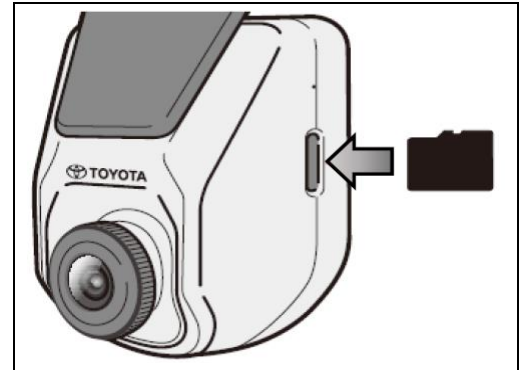

**Note:**

1. Please ensure DVR is turned off before proceeding to install or remove memory card.
2. Installing memory card while driving is not advisable. Any cause is at your own risk.

### 3.2 Formatting the memory card

When a memory card is installed, you will be asked to format the memory card. Please press  > **Format Memory**.

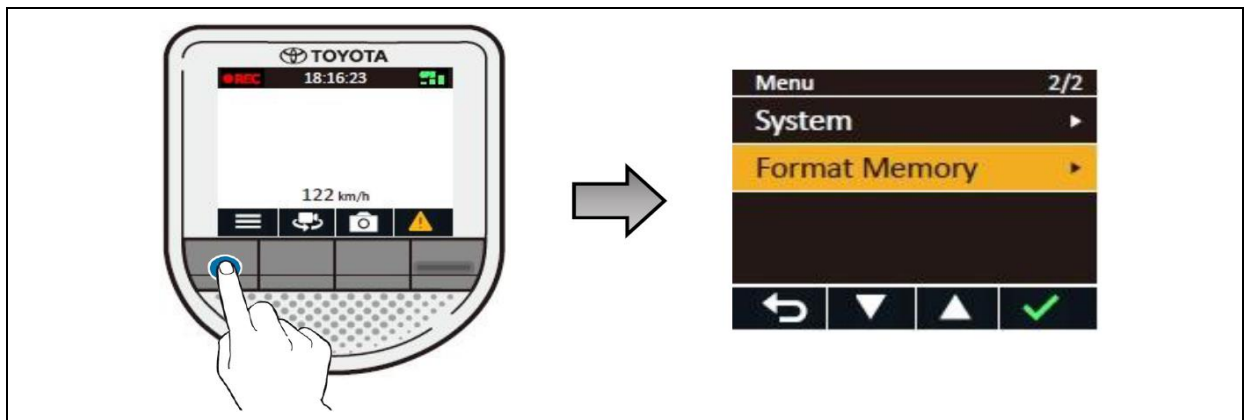

**Note:**

1. Formatting memory card will delete all existing files in the memory card. It is recommended to back up files before proceeding with formatting.
2. Formatting memory card while driving is not advisable. Any cause is at your own risk.



# SECTION 3.0

## Operating Digital Video Recorder (DVR)

### 3.3 About the memory card

- a. A memory card is required in order to enable DVR to initiate recording
- b. This DVR supports Class 10 MicroSD Card with the capacity range between 16GB -128GB only.
- c. Do NOT apply pressure to the centre of the memory card.
- d. The manufacturer does not guarantee the product's compatibility with memory card from all manufacturers.
- e. Be sure to format the memory card using the DVR at initial stage.

**Note:**

Any other memory card used besides recommended setup may not allow DVR to function properly.

> The following information is the memory card capacity and maximum estimated recording time (*Table is based on highest resolution setting of device*).

	16 GB	32 GB	64 GB	128 GB
Normal Recording	34 minutes	72 minutes	146 minutes	277 minutes
Emergency Recording	18 minutes	38 minutes	78 minutes	147 minutes
Photos	262 files	542 files	1102 files	2082 files

**NOTE:**

The values in the table provided are estimations based on brand new SD cards as recommended by the device manufacturer. Using a SD card with larger memory space will enable the device to retain more video files before the device rewrites over older files when the SD card is full.

**\* This device comes with a 16GB memory card**







## SECTION 4.0

### Operating Digital Video Recorder (DVR)

#### IMPORTANT NOTICE:

1. Once the vehicle engine is started, the DVR will automatically turn on.
2. Do not operate the DVR while driving. Any cause is at own risk.

#### 4.1 Normal Recording

The system will automatically begin normal recording shortly after start-up. When normal recording is in progress, you can manually stop recording by pressing . Press  to return to **HOME** screen and the system will start normal recording automatically.

The recordings may be divided into 3-minute segmented video clips; recording will not stop between video clip segmentation. When your memory card fills up with normal recordings, it will automatically overwrite the oldest existing files in this category.

The normal recordings can be found in the “**Normal Recording**” category on “**File Playback**”.

#### 4.2 Emergency Recording

By default, if an event such as a sudden impact, high speed driving, an aggressive turn or an accidental crash during normal recording has been detected by the DVR, the G-sensor will automatically prompt the system to record event under “**Emergency Recording**” category.

**NOTE:** You can change the sensitivity level of the G-sensor by selecting  > Video Recording > G-Sensor.

If you want to manually start an emergency recording while normal recording is in progress, press the **RED BUTTON** on the Front DVR. The emergency recording will save the duration from 3 seconds before the event and 17 seconds after the event. The emergency recording can last up to 1 minute if the sensor is triggered again during the emergency recording.

When the memory card fills up with emergency recordings, it will automatically overwrite the oldest existing files in this category. The emergency recordings can be found in the “Emergency Recording” category on “File Playback”.



# SECTION 4.0

## Operating Digital Video Recorder (DVR)

### 4.2 Capturing a photo

When the recording is in progress, press  to take a photo. The photos captured can be found in the “Photo” category on “File Playback”.

**NOTE :** Photo function is only available for the Front DVR.

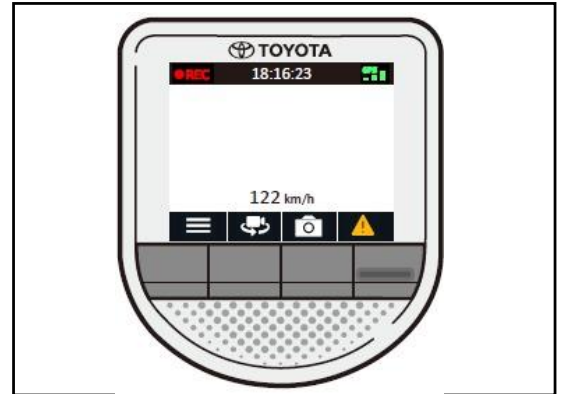



# SECTION 5.0

## Managing Files on DVR

To view and manage the videos and photos on the DVR, select > **File Playback**.

**NOTE :** Do not manage files on DVR while driving. Any cause is at own risk.

### 5.1 Playing videos

1. Select > **File Playback** and then select the desired category between Normal Recording, Emergency Recording or Parking Recording.
2. Press or to select the desired file from the list and then press to start playback.



### 5.1 Playing rear videos

The “D” icon displayed on the top right of each thumbnail in playlist indicates video comes with corresponding rear video. While playing the video, select > **Play rear video** to switch between front and rear videos.

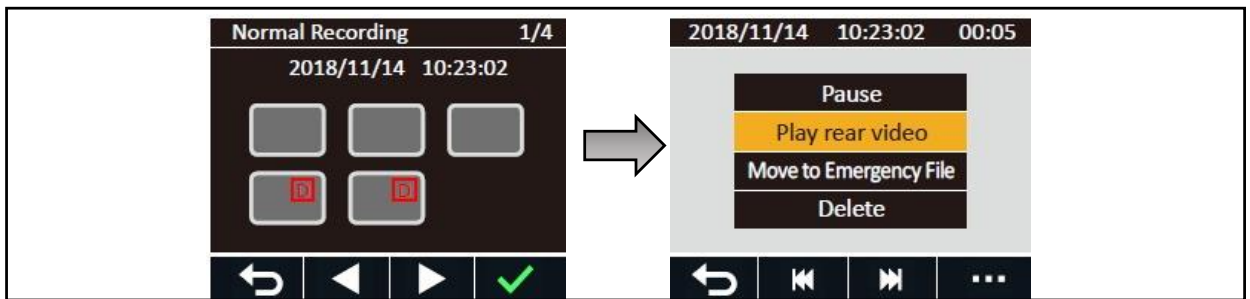



# SECTION 6.0

## Highway Buddy

The DVR provides advance driving safety functions to make your driving safer. At HOME screen, select  > **Driving Safety** to enable “Highway Buddy” functions :

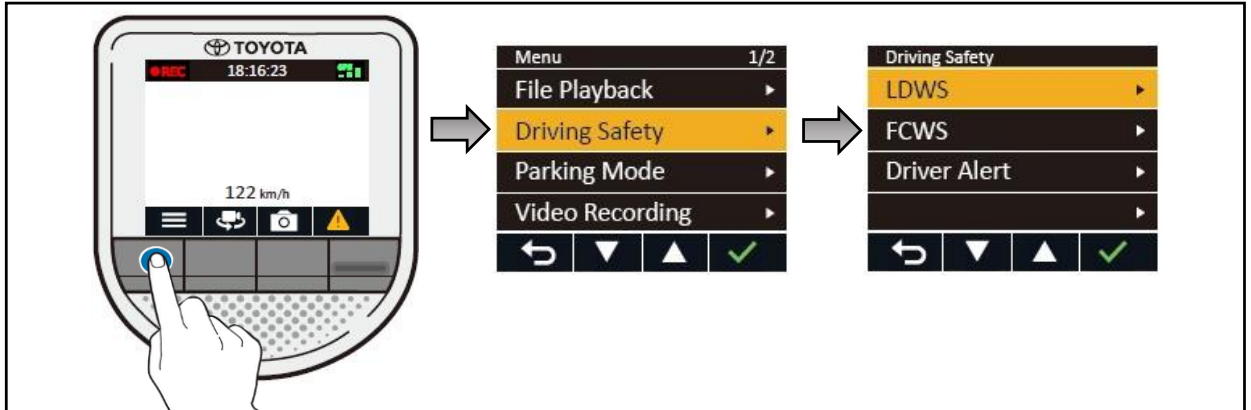

Device will prompt alert icons to warn the driver through the following Driving Safety features of Highway Buddy



Lane Departure Warning System (LDWS)



Forward Collision Warning System (FCWS)



**NOTE:** Do not change any setting for the Highway Buddy while driving. Any cause is at own risk.



## SECTION 6.1

### Lane Departure Warning System <LDWS>

#### 6.1.1 Introduction to LDWS

- a. The Lane Departure Warning System uses a camera to recognize visible white / yellow lines along the sides of your vehicle.
- b. When the system determines that the vehicle might depart from its lane, a warning activates and the lane departure warning icon appears for 3 seconds on the DVR screen to urge the driver remain within the lane.
- c. The warning has a sound alert that the user can choose to have turned ON or OFF.

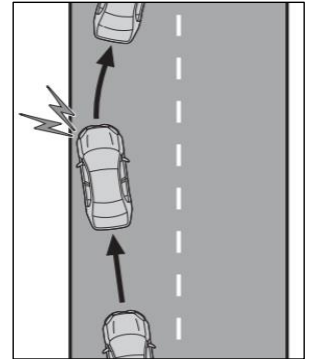

#### 6.1.2 Limitations of LDWS



- a. Do not rely solely upon the LDWS. The LDWS does not automatically drive the vehicle or reduce the amount of attention that must be paid to the area in front of the vehicle.
- b. The driver must always assume full responsibility for driving safely by paying careful attention to the surrounding conditions and operating the steering wheel to correct the path of the vehicle. Also, the driver must take adequate breaks when fatigued, such as from driving for a long period of time.
- c. Failure to perform appropriate driving operations and pay careful attention may lead to an accident, resulting in death or serious injury.



## SECTION 6.1

### Lane Departure Warning System <LDWS>

#### 6.1.3 Changing Setting for LDWS

- a. LDWS remains Enabled / Disabled based on the setting it was on before the DVR was last powered off.
- b. The [LDWS OFF icon]  appears on the top bar of the DVR display when the system is disabled.
- c. To Enable / Disable feature:
  1. Select  > **Driving Safety** > **LDWS** to enable the LDWS function.
  2. Select **General** > **ON** to enable the LDWS function
  3. Select **Sound** > **ON / OFF** to enable or disable the sound alert.

#### 6.1.4 Operational Conditions for LDWS

- a. The Lane Departure Warning System operates at speeds over 75 km/hour (approximately).
- b. The width of the traffic lane is approximately 3m (9.8 ft.) or more.
- c. The vehicle is driven on a straight road or around a gentle curve.
- d. The alert triggers when the camera detects the car is too close to the lane markers, when crossing over lines or when changing lanes.

#### 6.1.5 Conditions in which LDWS may not operate properly

In some situations such as the following, the DVR **may not** detect white (**yellow**) lines and various functions may not operate normally :

1. Objects or patterns that could be mistaken for white (yellow) lines are present on the side of the road (guardrails, curbs, reflective poles, etc)
2. White (yellow) lines are difficult to see due to rain, snow, fog, dust etc.
3. Asphalt repair marks, white (yellow) line marks, etc. are present due to road repair.
4. Vehicle is driven in a temporary lane or restricted lane due to construction work



**TOYOTA**  
ALL ABOUT THE DRIVE

## SECTION 6.1

### Lane Departure Warning System <LDWS>

5. Vehicle is driven in traffic lanes other than on highways and freeways.
6. Vehicle is driven in a construction zone.
7. There are shadows on the road that run parallel with, or cover, the white (yellow) lines.
8. Camera lens receiving bright light such as the headlights of an oncoming vehicle or the sunshine.
9. The vehicle is driven where the road diverges or merges
10. The vehicle is driven on a slope.
11. The vehicle is driven on a road which tilts left or right, or winding road.
12. The vehicle is driven on an unpaved road or rough road.
13. The vehicle is driven around a sharp curve.
14. The traffic lane is excessively narrow or wide.
15. The vehicle is moving up and down a large amount due to road conditions during driving (poor roads or road seams)
16. The headlight lenses are dirty and emit a faint amount of light at night or the beam axis has deviated.
17. The vehicle is struck by a crosswind.
18. The vehicle has just changed lanes or crossed an intersection.
19. The vehicle is driven in an area without white (yellow) lines, such as in front of a tollgate or checkpoint, or at intersection, etc.
20. The white (yellow) lines are cracked or cracked, "Raised pavement marker" or stones are present
21. The white (yellow) lines cannot be seen or are difficult to see.
22. The vehicle is driven on road surface that is wet due to rain or puddles.
23. The traffic lines are yellow (which may be more difficult to recognize than lines that are white).
24. The white (yellow) lines cross over a curb.
25. The vehicle is driven on a bright surface, such as concrete.
26. The vehicle is driven on surface that is bright due to reflected lights.
27. The vehicle is driven in an area where the brightness changes suddenly, such as at the entrances and exits of tunnels.
28. The vehicle is driven on a crooked road.
29. The vehicle is driven in an area that has very poor/no GPS signal.



## SECTION 6.2

### Forward Collision Warning System <FCWS>

#### 6.2.1 Introduction to FCWS

- a. The Forward Collision Warning System uses a camera to detect vehicles in front of your vehicle.
- b. When the system determines that the possibility of a frontal collision is high, a warning activates and the forward collision warning icon appears for 3 seconds on the DVR screen to urge the driver to take evasive action.
- c. The warning has a sound alert that the user can choose to have turned ON or OFF.

#### 6.2.2 Limitations of FCWS

- a. The driver is solely responsible for safe driving. Always drive safely, taking care to observe your surroundings. This system will not prevent collisions or lessen collision damage or injury in every situation. Do not overly rely on this system. Failure to do so may lead to an accident, resulting in death or serious injury.
- b. Although this system is designed to help avoid a collision, its' effectiveness may change according to various conditions, therefore the system may not always be able to achieve the same level of performance.

#### 6.2.3 Changing Setting for FCWS

- a. FCWS remains Enabled / Disabled based on the setting it was on before the DVR was last powered off.
- b. The [FCWS OFF icon]  appears on the top bar of the DVR display when the system is disabled.
  1. Select **☰ > Driving Safety > FCWS** to enable the FCWS function.
  2. Select **General > ON** to enable the FCWS function.
  3. Select **Sound > ON / OFF** to enable or disable the sound alert.





# SECTION 6.2

## Forward Collision Warning System <FCWS>

### 6.2.4 Operational Conditions for FCWS

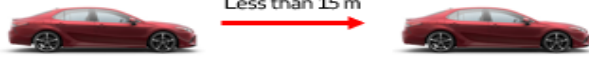
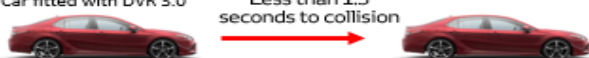
FCWS Activation	Scenarios that trigger FCWS alert	Warning types	After an Alert
Speed above 5km/h	<b>a. Distance Scenario</b> 15 meters distance from the car in front  Car fitted with DVR 3.0 	<b>Icon Warning:</b> Icon image appears for 3 seconds  <b>Audio Warning:</b> Audio alert beeps for 3 seconds	Keep the user's car at a distance of over 30 meters behind for a duration of 10 seconds from the car ahead to Re-Activate FCWS function
	<b>b. Speed Scenario</b> Expected Collision time with front car less than 1.5 seconds  Car fitted with DVR 3.0 		

### 6.2.5 Conditional in which FCWS may operate even when there is no possibility for collision

In some situations such as the following, the system may determine that there is a possibility of a frontal collision and operate.

1. When passing a vehicle.
2. When changing lanes while overtaking a preceding vehicle.
3. When overtaking a preceding vehicle that is changing lanes.

4. When overtaking a preceding vehicle that is making a left/right turn. (See image )

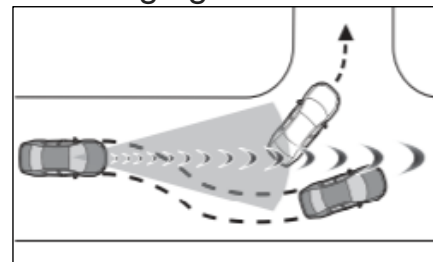

5. If the front of the vehicle is raised or lowered, such as when the road surface is uneven or undulating. When rapidly closing in on vehicle ahead.

6. When passing a vehicle in an oncoming lane that has stopped to make a left/right turn. (see image )

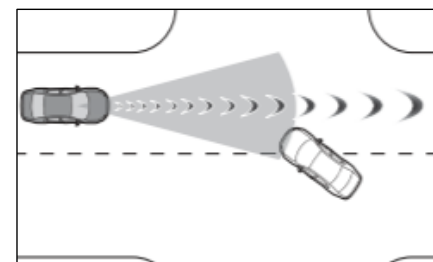



## SECTION 6.2

### Forward Collision Warning System <FCWS>

7. When approaching objects on the roadside, such as guardrails, utility poles, trees, or walls.

8. When driving on a road where relative location to the vehicle ahead in an adjacent lane may change, such as on a winding road. (see image)

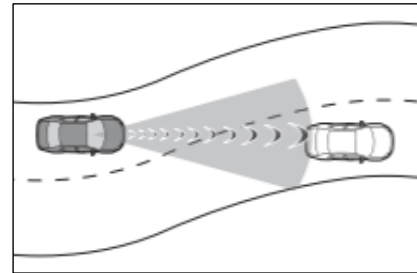

9. When driving on a road where relative location to the vehicle ahead in an adjacent lane may change, such as on a winding road.

10. When driving on a narrow path surrounded by a structure, such as in a tunnel or on an iron bridge.

11. When there is a metal object (manhole cover, steel plate, etc.), steps or a protrusion on the road surface or roadside.

12. When there is a vehicle or object by the roadside at the entrance of a curve. (see image)

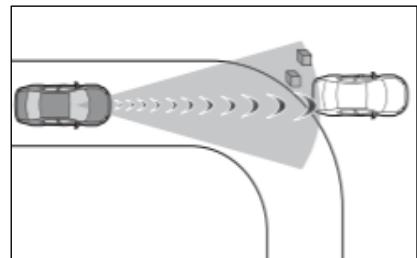

13. When rapidly closing in on an electric toll gate barrier, parking area barrier, or other barriers that open and closes.

14. When the vehicle is hit by water, snow, dust, etc. from a vehicle ahead.

15. When passing through a place with a low structure above the road. (see image)

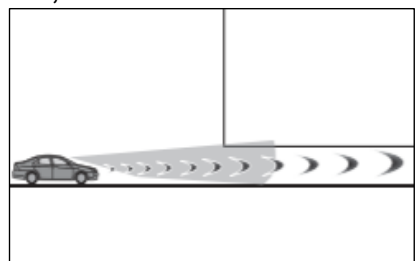

16. When passing under an object at the top of an uphill road. (see image)

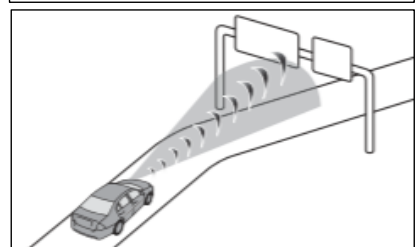



## SECTION 6.2

### Forward Collision Warning System <FCWS>

- 17. When driving through steam, smoke or haze.
- 18. When there are patterns or paint on the road or a wall that may be mistaken for a vehicle.

- 19. When driving through or under objects that may come in contact with the vehicle, such as thick grass or tree brunches. *(see image)*

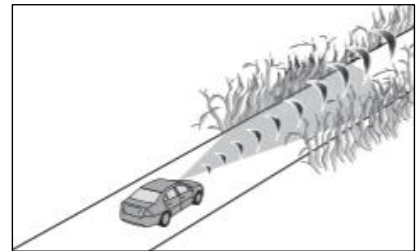

#### 6.2.6 Conditions in which FCWS may not function accurately

In some situations such as the following, a vehicle may not be detected by the DVR, preventing the system from operating properly:

- 1. If an oncoming vehicle is approaching your vehicle.
- 2. If the object/vehicle ahead is a human being, motorcycle or bicycle.
- 3. When approaching the side or front of a vehicle.
- 4. If a preceding vehicle has a small rear end, such as an unloaded truck.

- 5. If a preceding vehicle has a low rear end, such as a low bed trailer. *(see image)*

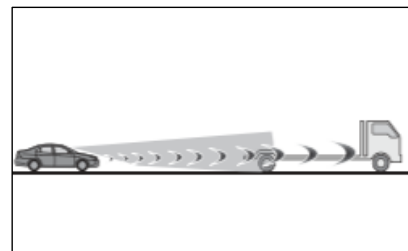

- 6. If a vehicle ahead is carrying a load which protrudes past its rear bumper.

- 7. If a vehicle ahead has extremely high ground clearance. *(see image)*

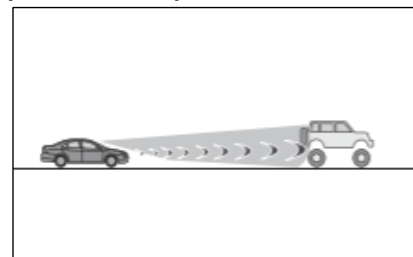

- 8. If a vehicle ahead is irregularly shaped, such as a tractor or side car.
- 9. If the sun or other light source is shining directly on a vehicle ahead.



## SECTION 6.2

### Forward Collision Warning System <FCWS>

- 10. If vehicle cuts in front of your vehicle or emerges from beside vehicle.
- 11. If vehicle ahead makes an abrupt manoeuvre (such as sudden swerving, acceleration or deceleration).
- 12. When suddenly cutting behind a preceding vehicle.

- 13. When a vehicle ahead is not directly in front of your vehicle. (see image)

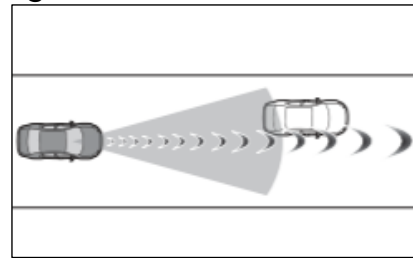

- 14. When driving in unpleasant weather such as heavy rain, fog, snow or a sandstorm.
- 15. When the vehicle is hit by water, snow, dust etc. from vehicle ahead
- 16. When driving through steam or smoke.
- 17. When driving in a place where the surrounding brightness changes suddenly, such as at the entrance or exit of a tunnel.
- 18. When a very bright light, such as the sun or the headlights of oncoming traffic, shines directly into the camera.
- 19. When the surrounding area is dim, such as at dawn or dusk, or while at night or in a tunnel.
- 20. After the engine has started the vehicle has not been driven for a certain amount of time.
- 21. While making a left/right turn and for a few seconds after making a left/right turn.
- 22. While driving on a curve and for a few seconds after driving on the curve.
- 23. If your vehicle is skidding.

- 24. If the front of the vehicle is raised or lowered. (see image)

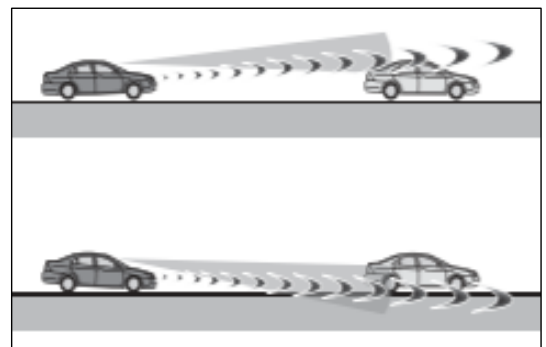



**TOYOTA**  
ALL ABOUT THE DRIVE

## SECTION 6.2

### Forward Collision Warning System <FCWS>

25. If a wiper blade is blocking the camera.
26. The vehicle is wobbling.
27. The vehicle is being driven at extremely high speeds.
28. When driving on a hill.
29. When the vehicle is stuck in standstill traffic conditions.
30. If the vehicle is driven in an area that has very poor/no GPS signal



## SECTION 6.3

### Driver Alert

The **Driver Alert** functions similarly to an alarm clock. The driver can opt to receive an alert from the DVR by selecting one the available pre-set timing of 1-3 hours. The system will trigger the alert after the pre-selected time period has elapsed to remind the driver to take a break from driving.

1. Select  > Driving Safety > Driver Alert and then set the period of time (1 hour, 2 hours or 3 hours).
2. Once enabled, the system will remind the user to take a break based on the set time period.

**NOTE :** The screen will display the visual alert and you will also receive audio warnings for 10 seconds. Press any button on device to snooze driver alert.



# SECTION 7.0

## Customizing the DVR

### 7.0 Customizing the DVR

To customise the system settings of the DVR, press  to access Main Menu screen.



### 7.1 Video Recording Settings

To change the settings of recording, press  > Video Recording

#### a. Video Resolution

Sets the video resolution of the video to either **FHD (1920 x 1080p)** or HD (1280 x 720p).

#### b. Exposure Value

Sets the exposure level to adjust the brightness of the image. When the rear camera is connected, you can select Front Camera or Rear Camera to set the value separately.

#### c. G-Sensor

Sets the sensitivity level of the G-Sensor that allows automatic triggering of the emergency recording while normal recording is in progress.

#### d. Stamps

Sets the information (Coordinates or G-Sensor) that will be displayed on the recorded video. Select Hide all and the information will not be displayed.



# SECTION 7.0

## Customizing the DVR

### e. Vehicle Speed Stamp

Displays the driving speed on the recorded video.

### f. Text Stamp

Displays customizable text information.

## 7.2 System Settings

To change the system settings of DVR, press  > **System**

### a. Date/Time



Sets the date and time fromm two options:

#### ➤GPS

The system will set the date and time based on GPS location.

#### ➤Manual

The system will display the date and time setting screen. Press

 or  to adjust the value of the selected field; press 

And repeat the step until all fields have been changed. When done, press 

### b.LCD Auto OFF

#### ➤Always ON

Keeps the LCD screen ON.

#### ➤30sec / 3min / 5min

Sets the timer for the LCD to turn off automatically after recording starts.

### c.Calibration

**NOTE :** Do not adjust calibrated device manually. Please visit your local Toyota Service Center if calibration is required.

### d.Default

Restores the system settings to factory default.

### e.About

Displays the software information.





# SECTION 8.0

## Product Specification

Feature	Specification
Processor	AIT 8238P
Image Sensor	2M Sony IMX307 CMOS
Resolution	Front Camera : FHD (1920 x1080p) HD (1280 x 720p)
	Rear Camera : FHD (1080p)
External Memory	Class 10 MicroSD Card (SDXC), 16-128GB
Display	2.0" LCD
Fixed Length	FOV 150° (Diagonal)
Aperture Range	F/#1.8
Exposure Value	-1 / -0.7 / -0.3 / 0 / 0.3 / 0.7 / +1.0
Automatic Recording	Yes
Recycled Recording	Yes
LCD Auto OFF	30 sec / 3 min / 5 min / Always ON
Date / Time	HH:MM:SS YYYY/MM/DD
Date Stamp / Time Stamp	ON / OFF
Exposure Control	Auto
Emergency Recording Mode	Yes
G-Sensor	3 Axis