

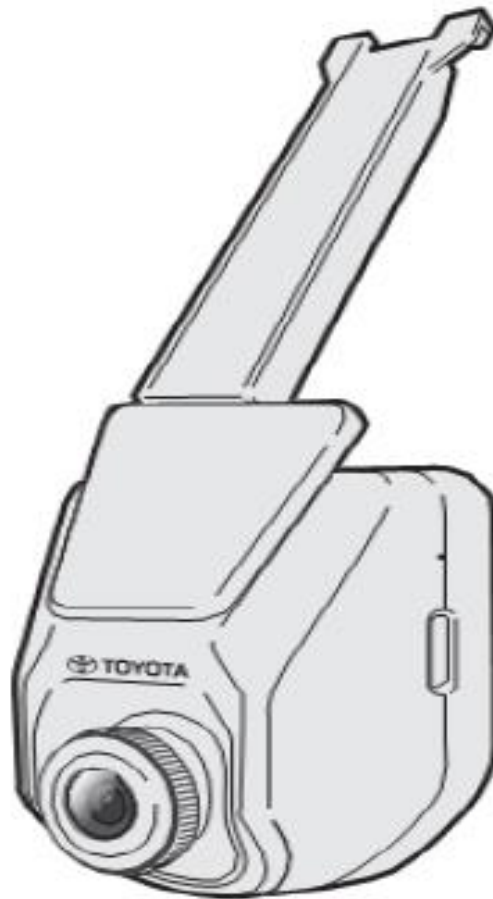

DIGITAL VIDEO RECORDER (DVR)



Please read this manual for proper operation and keep it for future reference.



TABLE OF CONTENTS

DIGITAL VIDEO RECORDER (DVR)

Section	Title	Page
1.0	Statements	
1.1	Important notice	1
1.2	About highway Buddy	1
2.0	Introduction to the DVR	
2.1	Front DVR	2
2.2	DVR Overview	3
3.0	Getting Started	
3.1	Installing the memory card	4
3.2	Formatting the memory card	4
3.3	About the memory card	5
4.0	Operating the DVR	
4.1	Normal recording	6
4.2	Emergency recording	6
4.3	Parking mode	7
4.4	Capturing a photo	8
5.0	Operation of the Smartphone Application	
5.1	Installing Toyota DVR Apps	9
5.2	Setting Up Wi-Fi Connection	10
5.3	Using Toyota DVR Apps	10
5.4	Changing Camera Setting	11
	Changing Camera Setting	12
6.0	Lane Departure Warning System <LDWS>	
6.1	Introduction to LDWS	13
6.2	Lamitations of LDWS	13
6.3	Changing setting for LDWS	14
6.4	Operational conditions for LDWS	14
6.5	Conditions in which LDWS may not operate properly	14
	Conditions in which LDWS may not operate properly	15

Please read this manual for proper operation and keep it for future reference.



TABLE OF CONTENTS

DIGITAL VIDEO RECORDER (DVR)

Section	Title	Page
7.0	Forwards Collision Warning System <FCWS>	
7.1	Introduction to FCWS	16
7.2	Lamitations of FCWS	16
7.3	Changing setting for FCWS	16
7.4	Operational Conditions for FCWS	17
7.5	Conditional in which FCWS may operate even when there is no possibility for collision	17 / 18
7.6	Conditional in which FCWS may not function accurately	19 to 21
8.0	Driver alert (DA)	
8.0	Driver alert (DA)	22
9.0	Product specification	
	Product specification	23

Please read this manual for proper operation and keep it for future reference.



TOYOTA

SECTION 1.0

Statements

1.1 Safety Instructions

Important notice:

Always use your best judgment, and operate your vehicle in a safe manner. Do not become distracted by the device while driving, and always be fully aware of all driving conditions. Minimize the amount of time spent viewing the device screen while driving.

Using this product does not change the requirement of the driver to take full responsibility for his or her behavior. This responsibility includes observing all traffic rules and regulations in order to avoid accidents, personal injury or property damage.

Please do not attempt removal of DVR unit from windshield – please visit your local Toyota Service Center if removal or calibration is required.

About Highway Buddy

Highway Buddy is a value-added feature that provides alerts to assist with Lane Departure and Forward Collision warnings, but it is not a replacement for the driver's attentiveness. The driver is still required to follow proper driving procedure to ensure personal safety, failure to do so may result in a serious accident, causing damage to property, serious injury or loss of life



SECTION 2.0

Introduction to the DVR

2.1 Front DVR

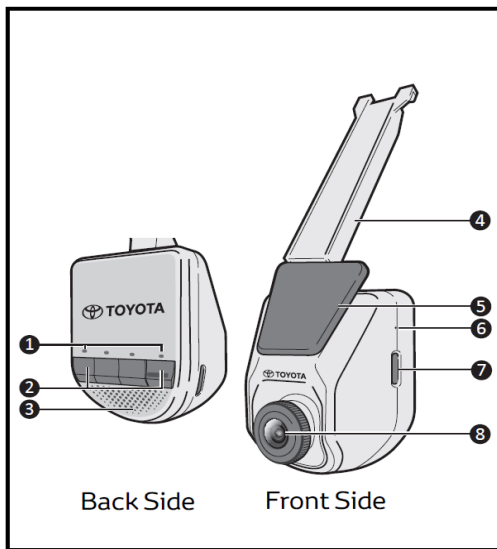

No.	Description
1	LED INDICATOR
2	FUNNCTION BUTTONS
3	SPEAKER
4	WIRING SLEEVE
5	WINDOW MOUNT
6	RESET BUTTON
7	MEMORY CARD SLOT
8	FRONT CAMERA



SECTION 2.0

Introduction to the DVR

2.3 DVR Overview

Button layout and functions: The DVR provides 4 function buttons to control the device.

LED indicators: The DVR has a function to notify its condition with the LED indicators of the corresponding function buttons. Symbols for LED conditions are as follows:

○	: On	☉	: Blinking
●	: Off	☉	: Quick blinking



1 Recording Button: Starts/Stop normal recording.

☉ (Green) : Normal recording is ongoing
(Front DVR only)

☉ (Amber) : Normal recording is ongoing
(Front + Rear DVR)

☉ (Green) : Front DVR error

☉ (Red) : Rear DVR error

☉ (Amber) : Front + Rear DVR error

2 Camera button : Takes a photo

☉^{x1} (Green)

3 Wifi button : Press 3 sec to turn on Wi-Fi. Wi-Fi will be turned off automatically after 1 minute of inactivity.)

○ (Blue) : Wi-Fi ON

☉ (Blue) : Wi-Fi connected

4 Emergency button : Manually starts emergency recording



SECTION 3.0

Getting Started

3.1 Installing the memory card

To install the memory card, Hold the card (MicroSD) by the edges and gently insert it into the slot until you hear a click. To remove a card, gently push the top edge of the card inwards to release it and pull it out of the slot.

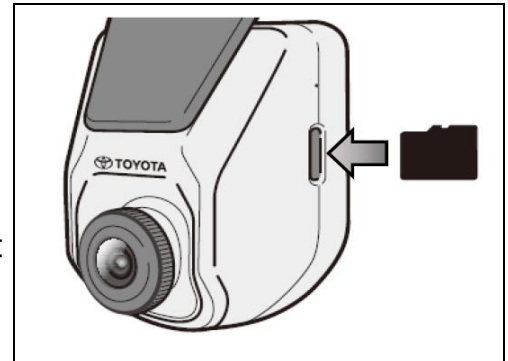

Note:

1. Please ensure DVR is turned off before proceeding to install or remove memory card.
2. Installing memory card while driving is not advisable. Any cause is at your own risk.

3.2 Formatting the memory card

When a memory card is installed, you can format the memory card by pressing the Recording button and Camera button simultaneously for 8 seconds. The 4 LED indicators blink at the same time during formatting.

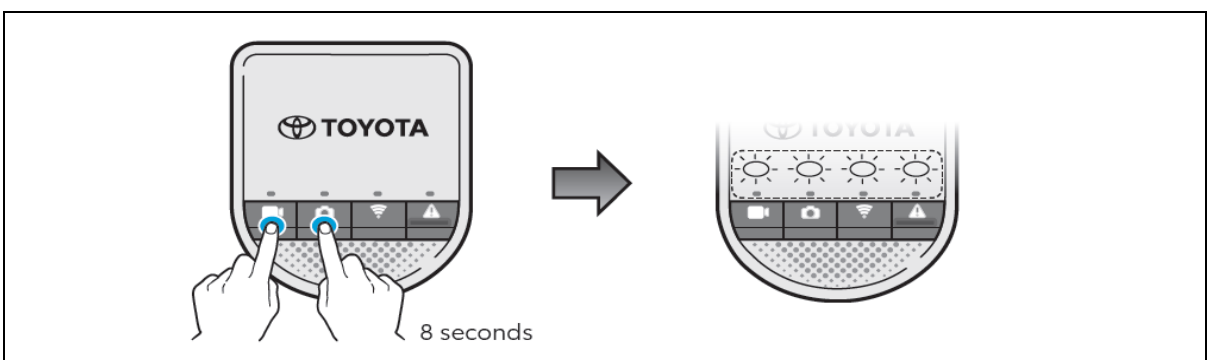

Note:

1. Formatting memory card will delete all existing files in the memory card. It is recommended to back up files before proceeding with formatting.
2. Formatting memory card while driving is not advisable. Any cause is at your own risk.



SECTION 3.0

Getting Started

3.3 About the memory card

- a. A memory card is required in order to enable DVR to initiate recording
- b. This DVR supports Class 10 MicroSD Card with the capacity range between 16GB -128GB only.
- c. Do NOT apply pressure to the centre of the memory card.
- d. The manufacturer does not guarantee the product's compatibility with memory card from all manufacturers.
- e. Be sure to format the memory card using the DVR at initial stage.

Note:

Any other memory card used besides recommended setup may not allow DVR to function properly.

- > The following information is the memory card capacity and maximum estimated recording time (*Table is based on highest resolution setting of device*).

	16 GB	32 GB	64 GB	128 GB
Normal Recording	34 minutes	72 minutes	146 minutes	277 minutes
Emergency Recording	18 minutes	38 minutes	78 minutes	147 minutes
Photos	262 files	542 files	1102 files	2082 files

NOTE:

The values in the table provided are estimations based on brand new SD cards as recommended by the device manufacturer.

Using a SD card with larger memory space will enable the device to retain more video files before the device rewrites over older files when the SD card is full.

*** This device comes with a 16GB memory card**



SECTION 4.0

Operating the DVR

IMPORTANT NOTICE:

1. Once the vehicle engine is started, the DVR will automatically turn on.
2. Do not operate the DVR while driving. Any cause is at own risk.

4.1 Normal Recording

The system will automatically begin normal recording shortly after startup. When normal recording is in progress, you can manually stop recording by pressing the Recording button. Once the recording stopped, press the button again to start normal recording.

The recordings may be divided into 3 minute segmented video clips; recording will not stop between video clip segmentation. When your memory card fills up with normal recordings, it will automatically overwrite the oldest existing files in this category.

The normal recordings can be found in the “Normal Recording” category.

4.2 Emergency Recording

By default, if an event such as a sudden impact, high speed driving, an aggressive turn or an accidental crash during normal recording has been detected by the DVR, the G-sensor will automatically prompt the system to record event under “**Emergency Recording**” category.

By default, if an event such as a sudden impact, high speed driving, an aggressive turn or an accidental crash during normal recording has been detected by the DVR, the G-sensor will automatically prompt the system to record event under “**Emergency Recording**” category.

If you want to manually start an emergency recording while normal recording is in progress, press the **RED BUTTON** (Emergency button) on the Front DVR.

The emergency recording will save the duration from 3 seconds before the event and 17 seconds after the event. The emergency recording can last up to 1 minute if the sensor is triggered again during the emergency recording.

When the memory card fills up with emergency recordings, it will automatically overwrite the oldest existing files in this category.



SECTION 4.0

Operating the DVR

4.3 Parking Mode

Your DVR supports the parking recording function. To enable the Parking Mode function, select > Wifi Activation > Toyota DVR App > Setting > Parking Mode > Detection > ON

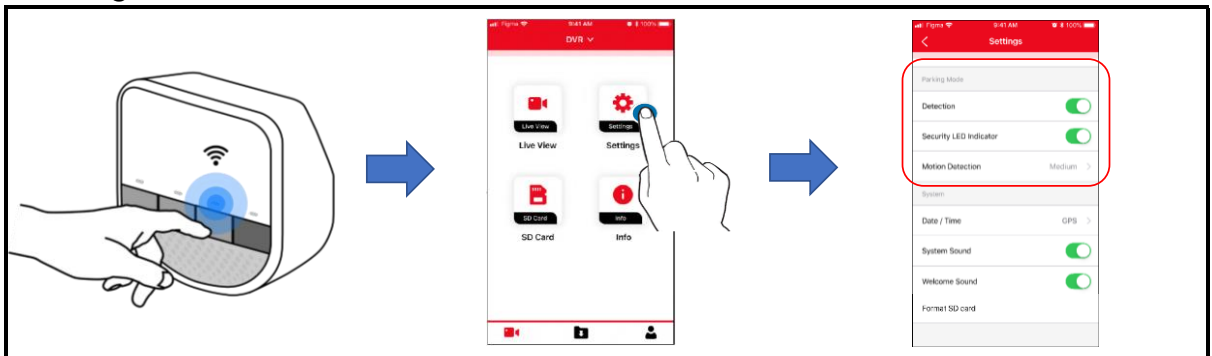

When “**Parking Mode**” is enabled, the system will activate the parking mode as soon as the vehicle is parked, and engine is turned off. During Parking Mode, the front camera of DVR will be on standby mode as it **would only trigger recordings when there is a motion detected.**

NOTE : The rear camera does not support motion detection.

The parking mode recording will save the duration from 3 seconds before the event and 17 seconds after the event.

The parking mode recording can last up to 1 minute if the sensor is triggered again during the emergency recording.

When the memory card fills up with parking mode recordings, it will automatically overwrite the oldest existing files in this category.

The parking mode recordings can be found in the “**Parking Recording**” category on “**File Playback**”.



SECTION 4.0

Operating the DVR

4.4 Capturing a photo

When the recording is in progress, press  to take a photo. The photos captured can be found in the “**Photo**” category .

NOTE : Photo function is only available for the Front DVR.

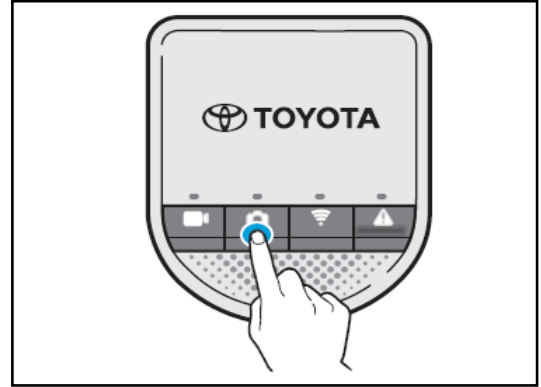



SECTION 5.0

Operation of the Smartphone Application

Videos recorded on this DVR can be directly viewed on your Android or Apple smartphone via the "Toyota DVR APP" app found on the Google Play Store or Apple Appstore.

The smartphone app can also be used to change various settings of the DVR according to your preference.



Note:

1. The instructions and images shown here are for reference only. The actual setting options and methods may vary depending on your phone type/model.
2. Video is not recorded while Dashcam is connected to the smartphone via Wi-Fi.
3. Please confirm Wi-Fi has been turned on; on your smartphone.
4. The smartphone app starts with the language set to the smartphone. However if a language other than the available settings in the app, it will start up with English as default.
5. The viewer app for smartphones can only be used if the smartphone is connected to Dashcam Wi-Fi.
6. For smartphone Wi-Fi settings and connection procedure please refer to your smartphone's instruction manual.

5.1 Installing Toyota DVR Apps

Search the "Toyota DVR APP" and download the app from your smartphone app store.

- For Android smartphone: Google Play
- For iPhone: App Store

Note: The Toyota DVR APP is compatible with iOS 11.0 (and above) and Android 5.0 (and above) devices. It is not guaranteed that the product's compatibility with smartphones from all manufacturers. Not all Toyota DVR models support the app or all its features.

Please read this manual for proper operation and keep it for future reference.

9/23



SECTION 5.0

Operation of the Smartphone Application

5.2 Setting Up Wi-Fi Connection

1. Turn on Wi-Fi on your DVR by pressing the Wi-Fi button. The Blue LED on the Wi-Fi button is ON.
2. Open the Toyota DVR APP and press the “+” icon.
3. Select the DVR Wi-Fi when your phone Wi-Fi settings page opens.
4. Return to the Toyota DVR APP to complete connection.

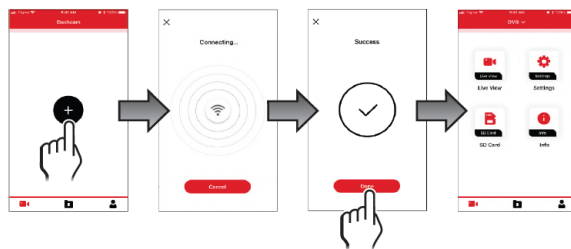

Note: To use the Toyota DVR APP, you need to enable the Location service on your smartphone. Follow the on-screen instructions to complete the settings when prompted.

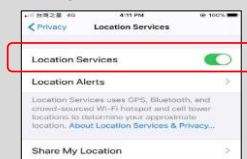



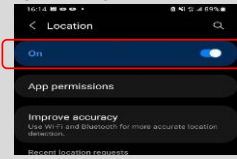



iPhone



Android Phone

5.3 Using Toyota DVR Apps

Once the DVR is connected, the screen will display the main page.

- Tap **Live View**  to watch the live video of the connected DVR to confirm camera view is clean and correct.
- Tap **Settings**  to change the settings for the DVR.
- Tap **SD Card**  to access the video list to download or delete the recordings on the DVR.
- Tap **Info**  to display the information of the DVR.
- Tap  to view the downloaded recordings.
- Tap  to change the storage location of the downloaded recordings (for Android users only), update the DVR firmware and view the information of the app.



SECTION 5.0

Operation of the Smartphone Application

5.4 Changing Camera Setting

The settings of the DVR can be changed. The new settings will take effect when Wi-Fi is disconnected.

1. On the main page of the viewer app, tap Settings 
2. Select the item of which setting is to be changed.

- **Video Recording**

Resolution: Sets the resolution of videos captured by the DVR.

EV: Sets the exposure level to adjust the brightness of the image.

G-Sensor Sensitivity: Sets the sensitivity level of the G sensor that allows automatic triggering of event recording while continuous recording is in progress.

Stamps: Sets the information that will be displayed on the recorded video.

Speed Stamp: Displays the driving speed on the recorded video.

- **Driving Safety**

Calibration: Follow the on-screen instructions to calibrate the system constantly in order to be alerted properly.

LDWS: Once enabled, the system will alert you when it detects that the car has strayed from its intended lane.



FCWS: Once enabled, the system will alert you when the car moves slowly and gets too close to the car ahead.

Driver Fatigue Alert: Once enabled, the system will remind you to take a break for a long-distance drive.

- **Parking Mode**

Detection: When enabled, the DVR will power up and start recording if an impact is detected, if the vehicle battery condition allows.

NOTE:

1. Tap the Detection button to enable or disable Parking Mode.
 : enabled  : disabled
2. Parking Mode feature is applicable to selected Toyota vehicles only.



SECTION 5.0

Operation of the Smartphone Application

Security LED Indicator: Turns on or off the flashing red LED indicator next to the camera lens, during Parking Mode.

Motion Detection: Sets the sensitivity level of motion detection.

- **System**

Date/Time: Sets the system date and time.

System Sound: Enables or disables system notification sounds.

Welcome Sound: Enables or disables the notification sounds during start-up.

Volume: Adjusts the volume level.

Restore to Default: Restores the system settings to the factory defaults.

Format SD card: Formats the memory card. (All data will be erased.)



SECTION 6.0

Lane Departure Warning System <LDWS>

6.1 Introduction to LDWS

- a. The Lane Departure Warning System uses a camera to recognize visible white / yellow lines along the sides of your vehicle.
- b. When the system determines that the vehicle might depart from its lane, a warning activates and the lane departure warning icon appears for 3 seconds on the DVR screen to urge the driver remain within the lane.
- c. The warning has a sound alert that the user can choose to have turned ON or OFF.

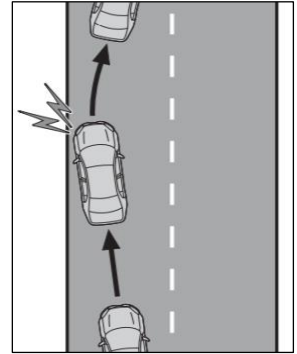

6.2 Limitations of LDWS

- a. Do not rely solely upon the LDWS. The LDWS does not automatically drive the vehicle or reduce the amount of attention that must be paid to the area in front of the vehicle.
- b. The driver must always assume full responsibility for driving safely by paying careful attention to the surrounding conditions and operating the steering wheel to correct the path of the vehicle. Also, the driver must take adequate breaks when fatigued, such as from driving for a long period of time.
- c. Failure to perform appropriate driving operations and pay careful attention may lead to an accident, resulting in death or serious injury.



SECTION 6.0

Lane Departure Warning System <LDWS>

6.3 Changing Setting for LDWS

- a. LDWS remains Enabled / Disabled based on the setting it was on before the DVR was last powered off.
- b. Use the Toyota DVR APP to Enable / Disable the LDWS feature.

6.4 Operational Conditions for LDWS

- a. The Lane Departure Warning System operates at speeds over 75 km/hour (approximately).
- b. The width of the traffic lane is approximately 3m (9.8 ft.) or more.
- c. The vehicle is driven on a straight road or around a gentle curve.
- d. The alert triggers when the camera detects the car is too close to the lane markers, when crossing over lines or when changing lanes.

6.5 Conditions in which LDWS may not operate properly

In some situations such as the following, the DVR **may not** detect white (**yellow**) lines and various functions may not operate normally :

1. Objects or patterns that could be mistaken for white (yellow) lines are present on the side of the road (guardrails, curbs, reflective poles, etc.)
2. White (yellow) lines are difficult to see due to rain, snow, fog, dust etc.
3. Asphalt repair marks, white (yellow) line marks, etc. are present due to road repair.
4. Vehicle is driven in a temporary lane or restricted lane due to construction work
5. Vehicle is driven in traffic lanes other than on highways and freeways.
6. Vehicle is driven in a construction zone.
7. There are shadows on the road that run parallel with, or cover, the white (yellow) lines.
8. Camera lens receiving bright light such as the headlights of an oncoming vehicle or the sunshine.



SECTION 6.0

Lane Departure Warning System <LDWS>

9. The vehicle is driven where the road diverges or merges
10. The vehicle is driven on a slope.
11. The vehicle is driven on a road which tilts left or right, or a winding road.
12. The vehicle is driven on an unpaved road or rough road.
13. The vehicle is driven around a sharp curve.
14. The traffic lane is excessively narrow or wide.
15. The vehicle is moving up and down a large amount due to road conditions during driving (poor roads or road seams)
16. The headlight lenses are dirty and emit a faint amount of light at night, or the beam axis has deviated.
17. The vehicle is struck by a crosswind.
18. The vehicle has just changed lanes or crossed an intersection.
19. The vehicle is driven in an area without white (yellow) lines, such as in front of a tollgate or checkpoint, or at intersection, etc.
20. The white (yellow) lines are cracked are cracked, "Raised pavement marker" or stones are present
21. The white (yellow) lines cannot be seen or are difficult to see.
22. The vehicle is driven on a road surface that is wet due to rain or puddles.
23. The traffic lines are yellow (which may be more difficult to recognize than lines that are white).
24. The white (yellow) lines cross over a curb.
25. The vehicle is driven on a bright surface, such as concrete.
26. The vehicle is driven on a surface that is bright due to reflected lights.
27. The vehicle is driven in an area where the brightness changes suddenly, such as at the entrances and exits of tunnels.
28. The vehicle is driven on a crooked road.
29. The vehicle is driven in an area that has very poor/no GPS signal.



SECTION 7.0

Forward Collision Warning System <FCWS>

7.1 Introduction to FCWS

- a. The Forward Collision Warning System uses a camera to detect vehicles in front of your vehicle.
- b. When the system determines that the possibility of a frontal collision is high, a warning activates and the forward collision warning icon appears for 3 seconds on the DVR screen to urge the driver to take evasive action.
- c. The warning has a sound alert that the user can choose to have turned ON or OFF.

7.2 Limitations of FCWS

- a. The driver is solely responsible for safe driving. Always drive safely, taking care to observe your surroundings. This system will not prevent collisions or lessen collision damage or injury in every situation. Do not overly rely on this system. Failure to do so may lead to an accident, resulting in death or serious injury.
- b. Although this system is designed to help avoid a collision, its' effectiveness may change according to various conditions, therefore the system may not always be able to achieve the same level of performance.

7.3 Changing Setting for FCWS

- a. FCWS remains Enabled / Disabled based on the setting it was on before the DVR was last powered off.
- b. Use the Toyota DVR APP to Enable / Disable the FCWS feature.



SECTION 7.0

Forward Collision Warning System <FCWS>

7.4 Operational Conditions for FCWS

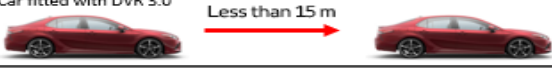
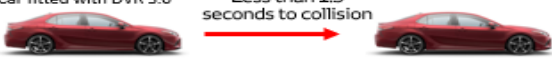
FCWS Activation	Scenarios that trigger FCWS alert	Warning types	After an Alert
Speed above 5km/h	a. Distance Scenario 15 meters distance from the car in front Car fitted with DVR 3.0 Less than 15 m 	Icon Warning: Icon image appears for 3 seconds Audio Warning: Audio alert beeps for 3 seconds	Keep the user's car at a distance of over 30 meters behind for a duration of 10 seconds from the car ahead to Re-Activate FCWS function
	b. Speed Scenario Expected Collision time with front car less than 1.5 seconds Car fitted with DVR 3.0 Less than 1.5 seconds to collision 		

7.5 Conditional in which FCWS may operate even when there is no possibility for collision

In some situations such as the following, the system **may** determine that there is a possibility of a frontal collision and operate.

1. When passing a vehicle.
2. When changing lanes while overtaking a preceding vehicle.
3. When overtaking a preceding vehicle that is changing lanes.

4. When overtaking a preceding vehicle that is making a left/right turn. (see image)

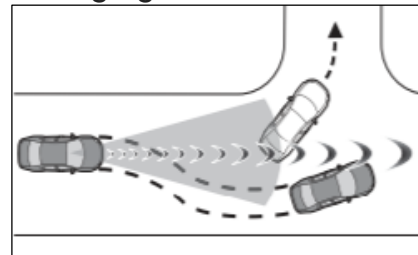

5. If the front of the vehicle is raised or lowered, such as when the road surface is uneven or undulating.
When rapidly closing in on vehicle ahead.

6. When passing a vehicle in an oncoming lane that has stopped to make a left/right turn. (see image)

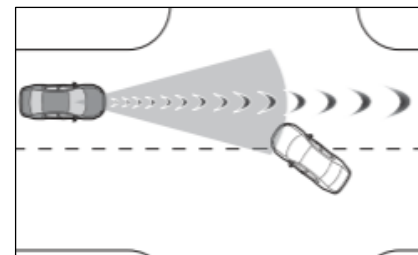



SECTION 7.0

Forward Collision Warning System <FCWS>

7. When approaching objects on the roadside, such as guardrails, utility poles, trees, or walls.

8. When driving on a road where relative location to the vehicle ahead in an adjacent lane may change, such as on a winding road. (see image)

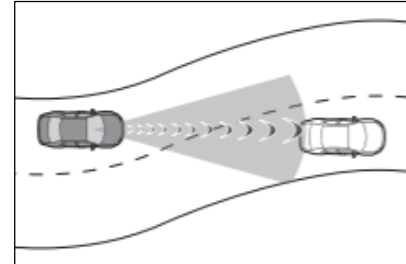

9. When driving on a road where relative location to the vehicle ahead in an adjacent lane may change, such as on a winding road.

10. When driving on a narrow path surrounded by a structure, such as in a tunnel or on an iron bridge.

11. When there is a metal object (manhole cover, steel plate, etc.), steps or a protrusion on the road surface or roadside.

12. When there is a vehicle or object by the roadside at the entrance of a curve. (see image)

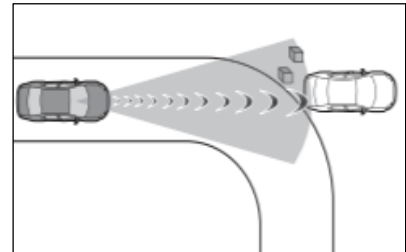

13. When rapidly closing in on an electric toll gate barrier, parking area barrier, or other barriers that open and closes.

14. When the vehicle is hit by water, snow, dust, etc. from a vehicle ahead.

15. When passing through a place with a low structure above the road. (see image)

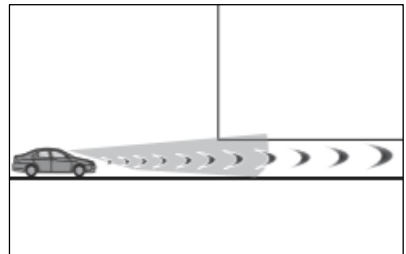

16. When passing under an object at the top of an uphill road. (see image)

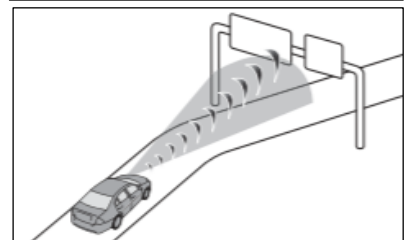



SECTION 7.0

Forward Collision Warning System <FCWS>

17. When driving through steam, smoke or haze.
 18. When there are patterns or paint on the road or a wall that may be mistaken for a vehicle.

19. When driving through or under objects that may come in contact with the vehicle, such as thick grass or tree branches.
(see image)

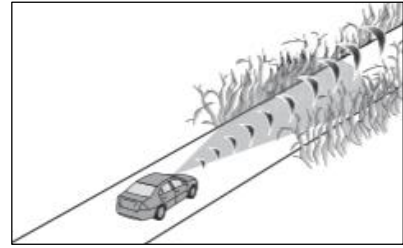

7.6 Conditions in which FCWS may not function accurately

In some situations such as the following, a vehicle **may not** be detected by the DVR, preventing the system from operating properly:

1. If an oncoming vehicle is approaching your vehicle.
2. If the object/vehicle ahead is a human being, motorcycle or bicycle.
3. When approaching the side or front of a vehicle.
4. If a preceding vehicle has a small rear end, such as an unloaded truck.

5. If a preceding vehicle has a low rear end, such as a low bed trailer. *(see image)*

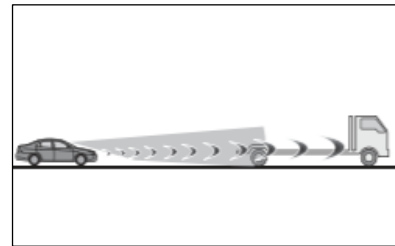

6. If a vehicle ahead is carrying a load which protrudes past its rear bumper.

7. If a vehicle ahead has extremely high ground clearance. *(see image)*

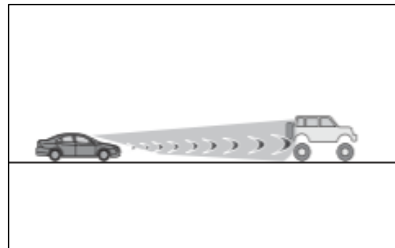

8. If a vehicle ahead is irregularly shaped, such as a tractor or side car.
9. If the sun or other light source is shining directly on a vehicle ahead.



SECTION 7.0

Lane Departure Warning System <LDWS>

- 10.If a vehicle cuts in front of your vehicle or emerges from beside a vehicle.
- 11.If a vehicle ahead makes an abrupt manoeuvre (such as sudden swerving, acceleration or deceleration).
- 12.When suddenly cutting behind a preceding vehicle.

- 13.When a vehicle ahead is not directly in front of your vehicle. (see image)

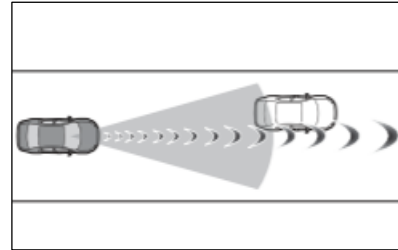

- 14.When driving in unpleasant weather such as heavy rain, fog, snow or a sandstorm.
- 15.When the vehicle is hit by water, snow, dust etc. from vehicle ahead
- 16.When driving through steam or smoke.
- 17.When driving in a place where the surrounding brightness changes suddenly, such as at the entrance or exit of a tunnel.
- 18.When a very bright light, such as the sun or the headlights of oncoming traffic, shines directly into the camera.
- 19.When the surrounding area is dim, such as at dawn or dusk, or while at night or in a tunnel.
- 20.After the engine has started the vehicle has not been driven for a certain amount of time.
- 21.While making a left/right turn and for a few seconds after making a left/right turn.
- 22.While driving on a curve and for a few seconds after driving on the curve.
- 23.If your vehicle is skidding.

- 24.If the front of the vehicle is raised or lowered. (see image)

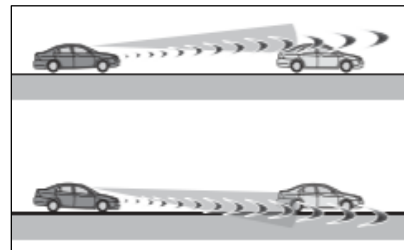



TOYOTA

SECTION 7.0

Lane Departure Warning System <LDWS>

25. If a wiper blade is blocking the camera.
26. The vehicle is wobbling.
27. The vehicle is being driven at extremely high speeds.
28. When driving on a hill.
29. When the vehicle is stuck in standstill traffic conditions.
30. If the vehicle is driven in an area that has very poor/no GPS signal



SECTION 8.0

Driver Alert

8 Driver Alert (DA)

The Driver Alert functions similarly to an alarm clock. The driver can opt to receive an alert from the DVR by selecting one the available pre-set timing of 1-3 hours. The system will trigger the alert after the preselected time period has elapsed to remind the driver to take a break from driving.

1. Use the Toyota DVR APP to set the period of time (1 hour, 2 hours or 3 hours).
2. Once enabled, the system will remind the user to take a break based on the set time period.



SECTION 6.1

Product Specification

8.0 Product Specification

Feature	Specification
Processor	SAV831D
Image Sensor	2M Sony IMX307 CMOS
Resolution	Front Camera : FHD (1920 x1080p) HD (1280 x 720p)
	Rear Camera : FHD (1080p)
External Memory	Class 10 MicroSD Card (SDXC), 16-128GB
Fixed Length	FOV 150° (Diagonal)
Aperture Range	F/#1.8
Exposure Value	-1 / -0.7 / -0.3 / 0 / 0.3 / 0.7 / +1.0
Automatic Recording	Yes
Recycled Recording	Yes
Date / Time	HH:MM:SS YYYY/MM/DD
Date Stamp / Time Stamp	ON / OFF
Exposure Control	Auto
Emergency Recording Mode	Yes
G-Sensor	3 Axis